

ERCOUPE

FORNEY

ALON

MOONEY M-10



Ercoupe-Forney-Alon-Mooney

Ercoupe Section Index

<i>Section</i>	<i>Page Number</i>
Manuals.....	3-2
Center Section.....	3-2
Wing.....	3-2, 3-3
Aileron.....	3-3
Stabilizer.....	3-3
Elevator.....	3-3
Fin.....	3-3
Rudder.....	3-3
Fuselage Structure.....	3-4
Main Landing Gear.....	3-5
Double Arm Nose Gear Conversion Kit.....	3-6
Double Arm Nose Gear Assembly.....	3-7
Steel Nose Gear.....	3-8, 3-9
Engine and Cowling.....	3-10, 3-11
Oil and Fuel System.....	3-10, 3-11
Instruments.....	3-12, 3-13
Control Surfaces.....	3-13, 3-14
Furnishings.....	3-14
Electrical.....	3-14
Bushings and Bearings.....	3-14
M-10 Cadet.....	3-14
Service Kits.....	3-15-3-17
Windows and Windshields.....	3-17
Service Assemblies.....	3-18

For items such as batteries, brakes, propellers, wheels and windshields, look in the specific sections in this catalog.



Manuals

<i>Description</i>	<i>Part Number</i>
--------------------	--------------------

Alon A-2 Flight Manual	
Manual originally produced for U.K. CAA ..LFM	
Alon A-2 Service Bulletins	LSB
Alon A-2 Service Manual	LSM
Alon A-2A Owners Manual	LWM
Ercoupe Service Bulletins/Memos	EBM
Ercoupe Flight Manual, 415C*	CFM
* The 415-C originally did not have a flight manual. It was not required at the time. (Ref Ercoupe Info letter No. 2). What we supply is the 415-D flight manual and include a 415-C Weight & Balance Supplement.	
415-C Weight & Balance Supplement	EFSM
(Included with the 415-C Flight Manual)..CFM)	
Ercoupe Flight Manual, 415D.....	DFM
Ercoupe Flight Manual, 415E/G/F1	EGF
Fundamentals of Elementary Ercoupe Flight Maneuvers.....	EFM
Ercoupe Owners Instruction Manual	EWM
Ercoupe Parts Catalog	EPM
Ercoupe Service Manual	ESM
Ercoupe Specifications, ADs and STCs	ESS
Forney Flight and Operation Manual for F1A	F1A
Forney Parts Manual, F1A.....	FPM
Forney Service Manual, F1/F1A	FSM

Manuals (continued)

<i>Description</i>	<i>Part Number</i>
Forney Instruction Manual, F1.....	FWM
Mooney Owners Manual, 1969 M-10..	MWM69
Mooney Owners Manual, 1970 M-10..	MWM70
Mooney M-10 Parts Catalog	MPM
Mooney M-10 Service Manual.....	MSM

PC 119

Center Section

<i>Description</i>	<i>Part Number</i>
Right Hand Cowl Emblem	415-00011
Left Hand Cowl Emblem	415-00012
Wing to Center Section, Upper Fairing ..	415-00014-L/R
Wing to Center Section, Lower Fairing ..	415-00015-L/R
Center Section Diagonal Rib**	415-13004-L/R
Rear Beam Hinge*	F13009
End Rib, SN 1-112.....	415-13014-L/R
Walkway Outer Rib Assembly*	415-13015-L/R
Rib Assembly, Inner Walkway*	415-13016-L/R
Trailing Edge Walkway Rib*.....	415-13017-L/R
Trailing Edge Walkway End Rib*.....	415-13018-L/R
Front Lower Fitting	415-13021-L/R
Center Section Gusset**	415-13023-L/R
Upper Fitting	415-13025-L/R
Lower Rear Fitting	415-13038-L/R
Walkway Box Upper Skin Assy.*	415-13040-1L/1R
Rear Beam Splice**	F13049
Center Fillet	415-13054-L/R
Trailing Edge Fillet	415-13055-L
Belly Skin Outer Bottom Stiffener ..	415-13056-L/R
Belly Skin, Assembly	415-13058
Belly Skin, Bare	415-13058-1
Belly Skin Inner Bottom Stiffener.....	F13058-3-L/R
Center Section, Reinforcement**	F13062
Shim.....	415-13065
Belly Skin Reinforcement Kit	415-13066
Rear Beam (used in SK-9).....	415-13103-L/R
Window Track Assembly.....	415-13106-L/R
Window Track Bracket	415-13107-L/R
Reinforcement	F13109
Walkway Box End Rib Assembly, SN 813 and up*	F13114-L/R

Center Section Lower Skin Inspection Plate Kit-Complies with SB-31 & AD2202-16-02
Kit for Smooth Skins.....SK-80-1
Kit for Beaded Skins.....SK-80-2

Center Section Cap Strips

Upper (SN 1-812)	415-13027
Lower (SN 1-812)	415-13028
Upper (SN 813 and up)	415-13027
Lower (SN 813 and up).....	415-13128

Fillet Assembly, Leading Edge



Part Number **PC 125** F13060-L/R

Center Section (continued)

<i>Description</i>	<i>Part Number</i>
Front Beam Lower Front Fitting	415-13121-L/R
Front Beam Upper Front and Rear Fitting	415-13125-L/R
Front Beam Lower Rear Fitting.....	415-13138-L/R
Shim	F13144
Walkway Box Lower Skin Assembly, SN 813 and up	F13147-1-L/R
Center Section Notes	
* Parts included in SA-3, 3A, -4, -4A	
** Parts included in SA-5	

Wing

<i>Description</i>	<i>Part Number</i>
Leading Edge Skin	415-14002-1
Rib Splice Spacer	415-14002-2
Inner Rib Angle	415-14002-3
Air Speed Pressure Tube	415-14002-4
Inner Diagonal Rib	F14005-L/R
Inboard Rib	F14006-L/R
Front Beam Assembly	F14007-L/R
Rear Beam Assembly	415-14008-L/R
Tip Assembly (L,R)	415-14008-TA-L/R
Rear Beam Reinforcement Plate	415-14008-6
Outer Tip Former Rib	415-14009
Inner Tip Former Rib	F14010
Outer Diagonal Rib	415-14011-L/R
Rib Bow Tip Assembly	415-14012-L/R
Intermediate Nose Rib	F14013
Beam Splice Inner Nose Rib.....	F14015
Bow Skin Splice Nose Rib	F14016
Tip Nose Rib	415-14017-L/R
Front Beam to End Rib Gusset	415-14018
Bow Brace Rib	F14019-L/R
Rear Beam Hinge Assembly	415-14020-L/R
Rear Beam Outer Diagonal Gusset	415-14021
Rear Beam Bow End Rib Gusset ..	415-14022-L/R
Rear Beam Intermediate Rib Gusset.....	415-14023
Inboard Nose Rib	415-14026-L/R
Front Beam Tip Only	F14029-1L/-1R
Trailing Edge Rib	415-14030-L/R
Pitot Line Support Clip	F14033
Front Beam Diagonal Rib Gusset	415-14037

Ercoupe Wing Metalization STC (excludes aluminum)

Part Number

STC-SA319WE

This part requires four 3 X 10 foot sheets of aluminum. See 2024-T3-.020 on page 144 in the Raw Materials section of this catalog.

Wing Spar Cap Strips For SN 813 and up

Upper, Left	210300-L00
Lower, Left	210301-L00
Upper, Right	210300-R00

PC 125

Ercoupe-Forney-Alon-Mooney

Wing (continued)

Description	Part Number
Front Beam Attachment Fitting.....	
Left Hand (14039-L).....	PC 125210348-000
Right Hand (14039-R).....	PC 125210349-000
Front Beam Wing Attachment	
Fitting Spacer.....	415-14040
Front Beam Upper Inner Rib	
Gusset.....	415-14041-L/R
Pitot Head Support Bracket Assembly.....	415-14043
Tip Rear Reinforcement.....	415-14050-L/R
Intermediate Diagonal Rib.....	F14051-1-L/R
Fourth Diagonal Rib.....	F14051-2-L/R
Fifth Diagonal Rib.....	F14052-L/R
Tip Skin Reinforcement.....	415-14054
Tip Skin.....	415-14055-1-L/R
Tip Bow Brace Stiffener.....	415-14056
Celluloid Washer (per 100).....	415-14057
Beam Splice Outer Nose Rib.....	F14058
Rear Beam Tip.....	415-14061-L/R
Front Bow Tip Assembly.....	415-14066-L/R
Front Beam Shim.....	415-14067
Angle.....	415-14068-1
Angle.....	415-14068-2
Angle.....	415-14068-3
Stiffener.....	415-14068-4
Cover Patch Reinforcement (per 100) (415-14069).....	PC 3995001
Rear Beam Top Inner End Rib	
Gusset.....	415-14072-1-L/R
Rear Beam Lower Inner End Rib	
Gusset.....	415-14072-2-L/R
Rear Beam Splice Plate.....	415-14074
Front Beam Tip Assembly Flange.....	415-14075-L/R

Aileron

Description	Part Number
Aileron Assembly.....	F16001-L/R
Tip Rib.....	F16002-L/R
Aileron End Rib.....	415-16003-L/R
Aileron Inner Hinge Fitting Assembly.....	415-16005
Control Horn Assembly.....	415-16013-L/R
Trailing Edge.....	415-16016
Upper Skin Reinforcement.....	415-16017-3-L/R
Lower Skin Reinforcement.....	415-16020-1-L/R
Beam Assembly.....	415-16021-L/R
Lower Tip Skin Assembly.....	415-16023-1-L/R
Aileron Center Hinge Fitting Assembly.....	F16031
Diagonal Rib.....	415-16033-L/R
Aileron Upper Skin (skin only).....	F16034-L/R
Aileron Assembly Reinforcement.....	F16035
Aileron Lower Skin (skin only).....	F16038-1-L/R
Aileron Skin Reinforcement Kit.....	415-16039-5

Left / Right Hand Aileron Assembly



Part Number.....F16001-L/R

Stabilizer

Description	Part Number
Stabilizer Assembly (specify model).....	415-21001
Stabilizer Front Beam.....	F21002
Stabilizer Rear Beam.....	415-21003
Number 2 Rib.....	415-21005
Number 1 Nose Rib.....	415-21006
Number 2 Nose Rib.....	415-21007
Number 3 Nose Rib.....	415-21008
Number 4 Nose Rib.....	415-21009
Hinge Fitting Assembly.....	415-21011-L/R
Number 3 Rib.....	415-21012
Attach Fitting.....	F21013-L/R
Accessory Door.....	415-21014-L/R
Forward Attachment Fitting.....	F21015
Upper Stabilizer Skin (skin only).....	415-21022-1
Leading Edge Skin.....	F21025-L/R
Lower Skin.....	415-21028-1-L/R

Elevator

Description	Part Number
Elevator Beam.....	F22002
End Hinge.....	415-22007
Center Hinge.....	415-22008
Trailing Edge (22011).....	415-22023
(For use on airplanes with trim tabs only)	
Horn Assembly.....	415-22016
Elevator Horn Bushing (Oilite), A304-16.....	415-22016-1
Elevator Assembly with Trim Tab (models 415C, -CD, and -D).....	415-22017
Upper Elevator Skin (skin only).....	415-22019-1
Trim Tab Hinge.....	415-22026
Trim Tab Assembly (model 415-C).....	415-22027
Trim Tab Horn.....	415-22028
Trim Tab Assembly (models 415-CD and 415-D).....	415-22031
Trim Tab Assembly (model 415-E).....	415-22032
Trim Tab Hinge (model 415E).....	F22033
Trim Tab Spring (model 415-E) (22035).....	SK-288
Upper Right Skin.....	415-22037-1
Upper Left Skin.....	415-22037-2
Lower Right Skin.....	415-22037-3
Lower Left Skin.....	415-22037-4
Lower Center Skin.....	415-22037-5
Center Rib.....	415-22037-6
Intermediate Rib.....	415-22037-7
Center Left Rib (22037-8-L/R).....	F22043
Center Right Rib (22037-9-L/R).....	F22044
Control Arm (22037-14).....	F22047
Spar Stiffener (22037-15).....	F22048
Tab Hinge Spacer.....	415-22037-17
Up Stop Tab.....	415-22037-30
Upper Center Skin.....	415-22037-31
Split Elevator Center Hinge.....	F22038

Elevator (continued)

Ercoupe 415-E Split Elevator

Part Number.....415-22037

Elevator Assembly with Trim Tab for 415-C, CD, and -D



(Please specify serial number when ordering)

Part Number.....415-22017

Fin

Description	Part Number
Fin Assembly.....	F23001-L/R
Beam Channel.....	415-23004
Fin Spacer.....	415-23006
Fin Leading Edge.....	415-23010
Inner Skin.....	415-23011-1L/R
Outboard Skin (23009-1L/R).....	415-23011-1L/R

Fin and Rudder



Fin.....F23001-L/R

Rudder.....F24001-L/R

Rudder

Description	Part Number
Rudder Assembly.....	F24001-L/R
Mounting Bolt Spacer.....	F24001-17
Rudder Control Horn.....	F24002-L/R
Hinge Assembly.....	F24003
Outboard Skin	
Left Hand (24011-1-L).....	F24013-1-L
Right Hand (24011-1-R).....	F24013-1-R
Inboard Skin.....	F24013-1-L/R
Rib Assembly.....	F24015-L/R
Rudder Rib Kit (to comply with AD 59-25-05).....	SK-36

All items on this page are Price Code 120 unless otherwise noted

Price and availability subject to change without notice. Univair's Toll Free Sales: 1-888-433-5433

Ercoupe-Forney-Alon-Mooney

Fuselage Structure

<i>Description</i>	<i>Part No.</i>
Forward Lower Skin	415-31007-1
Master Cylinder Brake Hose.....	415-31007-19
Upper "B" Frame.....	F31009
Frame "E" Bracket.....	F31012-2
Frame Assembly "F".....	415-31013
Frame Assembly "G".....	415-31014
Frame Assembly "H".....	F31015
Frame Assembly "I".....	F31016
Frame Assembly "J".....	3F1017
Frame Assembly "K".....	F31018
External Longeron	F31019-L/R
Cone Reinforcement.....	415-31023
Stabilizer Mount Frame.....	415-31032
Inner Skin Assembly.....	415-31035
Clear Rear Window	415-31037
Tinted Rear Window.....	415-31037G
Tail Fairing Assembly	415-31039
Windshield Trim Cover.....	415-31041
Fuselage Lower Control Support ..	415-31044-L/R
Fuselage Upper Control Support ..	415-31045-L/R
Fuselage Rear Stiffener	415-31046
Reinforcement Angle	415-31052-7
Reinforcement Angle	415-31052-8
Bottom Skin Former	415-31054-L/R
Upper Firewall Fitting	415-31062-L/R
Lower Firewall Fitting left (F31063L)..... PC 125 ...600264-L00
Lower Firewall Fitting right.....	F31063-R
Antenna Support.....	F31068
Engine Top Cowl Support Bumper	F31076
Firewall.....	415-31078
Fuselage Channel	415-31089
Stiffener.....	415-31091-1
Stiffener.....	415-31091-2
Bottom Tail Cone Skin.....	415-31092
Side Tail Cone Skin	415-31093-1L/R
Top Tail Cone Skin.....	415-31094
Lower Firewall Skin (skin only)....	415-31099-1
Lower Frame "B" (31100).....	415-31100-1
Lower Half Frame "C"	415-31101
Support.....	415-31105-L/R
Frame "A" to "C" Lower Stiffener	F31106-L/R
Frame "A" to "B" Lower Longitudinal	415-31107-L/R
Frame "A" to "B" Stiffener	415-31108-L/R
Frame "A" to "C" Stiffener	F31109-L/R

Nose Cowl Mounting Rings



Mounting Ring For DZUS Fastener Cowl (SN 1-2623)	415-40244D
Mounting Ring For CAMLOC Fastener Cowl (SN 2624 and up).....	415-40244C

Fuselage Structure (continued)

Bubble Windshield Kit



Clear vision without distortion! This double curvature windshield will stop aggravating rain leaks and offers an appreciable amount of soundproofing. It can be installed on older Ercoupes and comes complete with installation kit.

Clear	SK-15
Tinted	SK-15A

Engine Rubber Shock Mounts For C series Continentals



Part Number	PC 201 ... 22387
-------------------	-------------------------

<i>Description</i>	<i>Part No.</i>
Frame "A" to "B" Upper Longitudinal	415-31110-L/R
Frame "A" to "C" Upper Longitudinal	415-31111-L/R
Gas Tank Support	415-31112-L/R
Stiffener Assembly	F31113-L/R
Frame "E" to "F" Lower Stiffener	F31114-L/R
Frame "D" to "F" Upper Stiffener ..	415-31115-L/R
Frame "E" to "F" Upper Stiffener....	415-31116-L/R
Fuselage Tank Brace.....	415-31118-L/R
Lower Firewall Reinforcement	415-31125
Firewall Reinforcement	415-31126
Windshield Weatherstrip, 65-inch.....	415-31130
Rear Window Sealing Rubber, 48-inch ..	F31131-1
Top Windshield Sealing Rubber.....	F31131-2
Fuselage Fuel Tank Sealing Rubber	F31131-3
Frame "E" to "F" Lower Stiffener	F31133-L/R
Gas Gauge Bracket	415-31137
Frame "D" Upper Support	415-31142
Attaching Bracket	F31143-L/R
Frame "D" Assembly (without 31142)	F31144
Upper Channel.....	F31145-L/R
Front Window Track Channel	415-31146-L/R
Channel.....	415-31147-L/R
Front Windshield Frame	415-31150

Fuselage Structure (continued)

<i>Description</i>	<i>Part No.</i>
Frame "D" Upper Splice Plate.....	415-31152
Floor Support	415-31154
Bottom Skin	F31160-1
Side Skin	F31160-2-L/R
Top Skin	F31160-3
Junction Box (31160-17).....	PC 625 ... 40099
Floor Assembly Support	415-31163
Floor Support	415-31169
Fitting Assembly	415-31184-L/R
Mounting Bracket	415-31187
Clear Rear Window, glass only (31190).....	415-31037
Tinted Rear Window, glass only (31190G) ..	415-31037G
Plate (31194)	415-31194-L
Windshield Strap Assembly.....	415-31204
Trim Crank Nameplate (SN 1623-4423).....	415-31211
Plate.....	415-31212
Windshield Front Frame	F31215
Panel to "B" Panel Brace.....	415-31228
Frame "A" to "C" Upper Longitudinal ..	415-31229
Bubble Windshield.....	F31232
Upper to Lower Firewall Stiffener	F31235-1
Panel to Fuselage Tank Panel Brace	F31237
Front Fuselage Upper Felt Pad	415-31238
Panel to Firewall Throttle Brace.....	F31239
Throttle to Brace Throttle Clamp	415-31241
Rear Section Upper Front Fuselage Skin.....	F31245-1
Frame "A" to "C" Side Skin	F31245-2-L/R
Forward Section Upper Front Fuselage Skin	F31245-5

Ercoupe Engine Mount



Part Number	F31920
-------------------	--------

Ercoupe Firewall



Part Number	415-31078
-------------------	-----------

Ercoupe-Forney-Alon-Mooney

Main Landing Gear

<i>Description</i>	<i>Part No.</i>
Lower Knee Joint Bushing*	415-33105
Piston End Assembly*	415-33109
Main Landing Gear Piston End Bushing (Oilite A515-11)	415-33109-1
Landing Gear Shock Pads	415-33115
Piston Cup*	415-33119
Knee Joint Shaft*	415-33128
Taper Attaching Washer*	415-33132
Upper Leg Assembly*	415-33144-L/R
Piston Assembly*	415-33164
Main Landing Gear Assembly*	415-33167-L/R
Brake Hose (33167-30*)	SK-58
Lower Leg and Axle Assembly* ..	415-33175-L/R
Main Landing Gear Lower Strut Attachment Bushing*	415-33175-4
Wheel Retaining Nut*	415-33176
Wheel Bearing Spacer*	415-33178
Main Landing Gear Assembly**	F33201-L/R
Knee Joint Lock Nut**	F33201-18
Lockwasher**	F33201-19
Knee Joint Brake Hose (33201-24)*	SK-58
Lower Leg**	F33203-L/R
Leg and Axle Assembly**	F33204-L/R
Lower Leg Axle**	F33205
Bakelite Bushing**	415-33206
Knee Joint Pin**	415-33209
Front Fairing	415-33210-L/R
Rear Oleo Strut Fairing**	415-33211

Cleveland Wheels and Brakes



SN 813 and up	199-06900
SN 113-812	199-07100
(FAA field approval required for 199-07100)	

PC 660

For Goodrich (Hayes) Wheels and Brakes on Ercoupes with serial numbers 113 thru 812, refer to pages 259 and 260 in the Tires, Wheels and Brakes section of this catalog.

Main Landing Gear Fairings



(SN 813 and up)415-33210-L/R

Description Part No.

Lower Leg Brake Tube Assembly** (33212)	SK-58
Wheel Retaining Nut**	F33213
Main Landing Gear Collar**	415-33214
Knee Joint Bakelite Washer**	415-33215
Brake Housing Attachment Screw** ..	415-33216
Landing Gear Screw**	415-33218
Upper Leg Assembly**	F33221-L/R
Knee Axle Bolt Lock Pin**	F33222
Oleo Strut Cylinder Spacer**	415-33224
Piston Assembly**	F33226
Cylinder Assembly (less Piston and Seal)**	415-33229
Snap Ring	415-33229-1
Oil Hole Cover**	415-33229-2
Sleeve Assembly**	415-33230
Oleo Strut Cylinder Tube Assembly** ..	F33232
Support	F33235
Flange	F33236
Lower Leg Bronze Bushing**	415-33239
Bumper Retainer	415-33245
Block	415-33246
Belleville Spring (used in SK-35)	A33251
Spacer (used in SK-35)	F33254
Main Landing Gear Fairing*	415-33305-L/R
Upper Fairing Spacer*	415-33306
Lower Fairing Spacer*	415-33307
Reservoir to Master Cylinder Hose.....	415-33424-12
Brake Cylinder to Front Beam Tube Assembly	415-33428
Brake Lower Leg Tube Assembly*	415-33429-L/R
Tee to Left Hand Landing Gear Tube Assembly*	415-33430
Tee to Right Hand Landing Gear Tube Assembly*	415-33431
Brake Pedal Support.....	415-33433-L/R
Brake Reservoir	U33443A
Bellcrank	415-33435
Brake Cable Bracket	415-33436
Brake Cylinder Support	415-33440
Pulley Guard	415-33442
Tube Fitting.....	415-33445
Brake Reservoir Plug.....	415-33447
Brake Cable Assembly	415-33448

Main Landing Gear (continued)

<i>Description</i>	<i>Part No.</i>
Left Hand Tee to Elbow Tube Assembly**	415-33455
Right Hand Tee to Elbow Tube Assembly**	415-33456
Brake Elbow to Hose Tube Assembly**	F33457-L/R
Brake Pedal Arm	F33458

Main Landing Gear Notes

* Effective on serial numbers 113-812

** Effective on serial numbers 813 and up

Landing Gear Shock Pads



Current rubber pads are a new, improved compound resulting from research performed for us by our supplier.

This material has superior weathering qualities. It is unaffected by hydraulic fluid and has greater resistance to static load.

Pads (8 required per plane)	A33115
Washer (SN 813 and up) (14 required per plane)	415-33224
(price per pad)	

For Double Arm Nose Gear Conversions and other Nose Gear parts, see pages 19-22 in this catalog.

Ercoupe Steering Pushrod Boot & Ring



Pushrod Boot

Doubler Ring

Made to fit original Ercoupe oval hole which is 1 1/2 inch wide and 1 13/16 inch high.

Holes larger than original will need 720082-000 doubler ring installed for correct boot fit.

Pushrod Boot	415-31058
Doubler Ring	PC 125720082-000

Meguiar's Mirror Glaze Polish and Cleaner



8 ounce bottles

Plastic Polish	PC 725MGH-10-8 oz
Plastic Cleaner	PC 725MGH-17-8 oz

All items on this page are Price Code 120 unless otherwise noted

Price and availability subject to change without notice. Univair's Toll Free Sales: 1-888-433-5433

Ercoupe-Forney-Alon-Mooney

Double Arm Nose Gear Conversion SK-17

FAA field approval required on kits SK-17A thru SK-17F

SK-17 Nose Gear Conversion Kit. The latest design in aluminum Double Arm forged Nose Fork, complete as shown at right. See parts details on the following page. Fits all **Ercoupe, Forney, Alon and Mooney M-10.**

SK-17A Nose Gear Conversion Kit. For the **Ercoupe, SN 183 through 4424** originally equipped with standard Steel Gear. This kit consists of part number 34371 forged aluminum Double Arm Fork assembly machined to fit your inner cylinder and the regular welded steel scissor attachment. Complete with 5.00 x 5 wheel, new first line tire and tube mounted on axle assembly. Quick change-over. Just remove the old single arm fork and replace it with the new Double Arm Fork. Replaces FMK-18.

SK-17B Nose Gear Conversion Kit. For **Ercoupe, SN 4425 and up** equipped with Electrol Gear, that used the 5.00 x 4 single bearing wheel. Same as SK-17A (above), except machined to the Electrol inner cylinder and original forged aluminum scissors.

SK-17C Nose Gear Double Arm Fork Conversion Kit. For **Ercoupe, SN 4425 and up**, to include the early **Forney Aircoupe** equipped with Electrol Gear with the large Single Arm Fork using the 5.00 x 5 double bearing wheel. This kit consists of a Double Arm Fork and Axle assembly only.

SK-17D Nose Gear Conversion Kit. Same as SK-17A, except Fork comes with hard chrome inner cylinder installed. (Steel Gear)

SK-17E Nose Gear Conversion Kit. Same as SK-17B, except Fork comes with hard chrome cylinder installed. (Electrol Gear)

SK-17F Scissors Modification Kit. Replaces the welded scissors used on the Steel Gear, SN 183 through 4424, with forged aluminum scissors. Scissors are machined to fit the Steel Gear, and the kit includes all necessary bolts and bushings for installation.

SK-17G Upper Nose Gear Cylinder Assembly. Consists of outer cylinder, lower bushing, inner bushing, inner and lower sleeves, upper and lower outer collar, rod and head, and shim. This assembly may be used to replace the worn out upper cylinder assemblies on all **Ercoupes, SN 4425 and up**, and early **Forneys.**



SK-17H Nose Gear Conversion Kit. Same as SK-17A, except without wheel, tire and tube.

NOTE: All nose gears use MIL 5606 (RED) hydraulic fluid

Improved Steering Joint Ball Kit

(This unit replaces part number 415-34074-2 Ball Stud)

This kit consists of rod-end bearing and all necessary hardware. It is FAA approved for all Ercoupe, Forney, Alon and M-10, when purchased from UNIVAIR. For use with the part number 52035 push-rod that has the male threaded stud.

Part Number.....SK-57
(steering collar not included)



For your Parts needs for the Electrol and Universal Aircraft Industries Nose Gear, call or fax UNIVAIR for price and availability.

UNIVAIR is the Type Certificate holder for Ercoupe, Forney, Alon and Mooney M-10.

Ercoupe-Forney-Alon-Mooney

**Ercoupe Steel Nose Gear
For aircraft serial numbers 187 through 4500**

See Page 33 for SK-31 Series
Nose Gear Service Kits

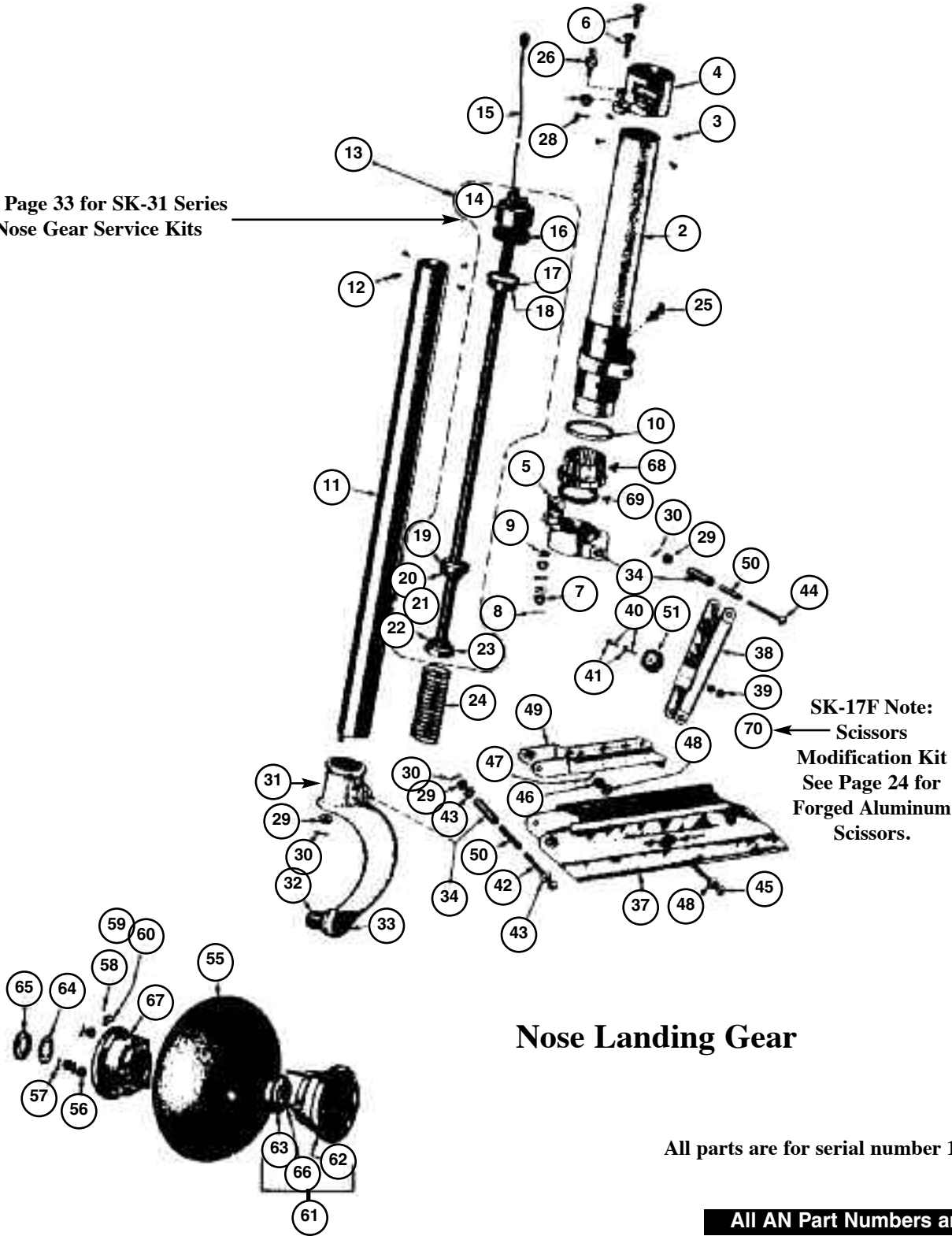

All items on this page are Price Code 120 unless otherwise noted

Price and availability subject to change without notice. Univair's Toll Free Sales: 1-888-433-5433

Ercoupe-Forney-Alon-Mooney

<i>Figure Number</i>	<i>Description</i>	<i>Part Number</i>	<i>Number Required</i>
not pictured	.Wheel Assembly without Bearing	34200-202 NO LONGER AVAILABLE	.1
not pictured	.Oleo Strut Assembly	NOT AVAILABLE	.1
2	.Outer Oleo Strut Assembly	415-34080	.1
3	.Screw	PC 580 AN510-10R4	.4
4	.Oleo Strut Steering Collar	F34029	.1
5	.Oleo Strut Steering Sleeve	415-34057	.1
6	.Bolt	PC 580 AN4-13	.2
7	.Castle Nut, sleeve to collar	PC 580 AN310-4	.2
8	.Cotter Pin	PC 580 AN380-2-2	.2
9	.Washer	PC 580 AN960-416L	.2
10	.Steering Sleeve Spacer Laminated Washer	F34051	.1
11	.Oleo Strut Inner Cylinder Assembly	415-34130	.1
12	.Screw	PC 580 AN510-6R4	.4
13	.Complete Oleo Strut Piston Assembly	34126 use 415-34126-5	.1
14	.Oleo Strut Piston Cylinder Rod and Head Assembly	34099 use 415-34099-2	.1
15	.Oleo Strut Gauge Assembly	415-34089	.1
16	.Oleo Strut Piston Shock Absorber	415-34087	.1
17	.Oleo Strut Piston Oil Seal Support	415-34129	.1
18	.Oleo Strut Piston Oil Seal	415-34126-1	.1
19	.Oleo Strut Piston Support Flange	415-34128	.1
20	.Nut	PC 580 AN365-1032	.2
21	.Bolt	PC 580 AN3-11A	.2
22	.Washer	PC 595 NAS1149F0332P	.2
23	.Oleo Strut Piston Orifice Fitting	415-34127	.1
24	.Oleo Strut Spring	F34041	.1
25	.Lubrication Fitting	PC 150 1637-B (34085-10)	.1
26	.Steering Joint Ball Fitting	415-34074-2	.1
27	.Nut	PC 580 AN310-6	.1
28	.Cotter Pin	PC 580 MS24665-283 (AN380-3-3)	.1
29	.Nut	PC 580 AN320-4	.3
30	.Cotter Pin	PC 580 AN380-2-2	.3
31	.Fork Assembly	NOT AVAILABLE	.1
32	.Wheel Axle	415-34111	.1
33	.Axle Snap Ring	415-34096-1	.1
34	.Nutcracker Phenolic Bushing	415-34042	.1
37	.Nutcracker Fairing	415-34020	.1
38	.Upper Nutcracker Link Assembly	NOT AVAILABLE	.1
39	.Nut	PC 590 MS21044-N06 (AN365-632)	.2
40	.Screw	PC 580 AN515-6-10	.2
41	.Washer	PC 580 AN960-6	.2
42	.Bolt	PC 580 AN4-24	.1
43	.Washer	PC 595 NAS1149F0432P	.2
44	.Bolt	PC 580 AN4-23	.1
45	.Bolt	PC 580 AN4-24	.1
46	.Nut	PC 580 AN320-4	.1
47	.Cotter Pin	PC 580 AN380-2-2	.1
48	.Washer	PC 580 AN960-416L	.2
49	.Lower Nutcracker Link Assembly	415-34019	.1
50	.Steel Nutcracker Bushing	415-34134	.2
51	.Rubber Nutcracker Bumper	415-34094	.1
52	.Wheel and Fork Assembly 5.00 x 4	NOT AVAILABLE	.1
55	.5.00 x 4 Tire (specify smooth or button tread)	NOT AVAILABLE	.1
56	.Nut	PC 580 AN310-4	.3
57	.Cotter Pin	PC 580 AN380-2-2	.3
58	.Type "A" Slotted Screw	PC 502 4X1/4-PSA-SS	.as required
59	.half-ounce Wheel Balance Weight	NOT AVAILABLE	.as required
60	.1-ounce Wheel Balance Weight	NOT AVAILABLE	.as required
61	.Left Wheel Rim Assembly	34200 NOT AVAILABLE	.1
63	.Wheel Bearing	NOT AVAILABLE	.1
64	.Wheel Washer (#WO-7) .032	415-34110-3	.1
65	.Wheel Lock Nut	415-34109	.1
66	.Wheel Bolt	PC 580 AN4-33A (34203)	.3
67	.Right Wheel Rim Assembly	34202 NOT AVAILABLE	.1
68	.Inner Lower Bearing	415-34133	.1
69	.O-Ring	PC 590 MS28775-328	.1
70	.Scissors Assembly (see SK-17F kit on page 19)	SK-17F	.1

All items on this page are Price Code 120 unless otherwise noted

SK-17 Nose Gear Assembly

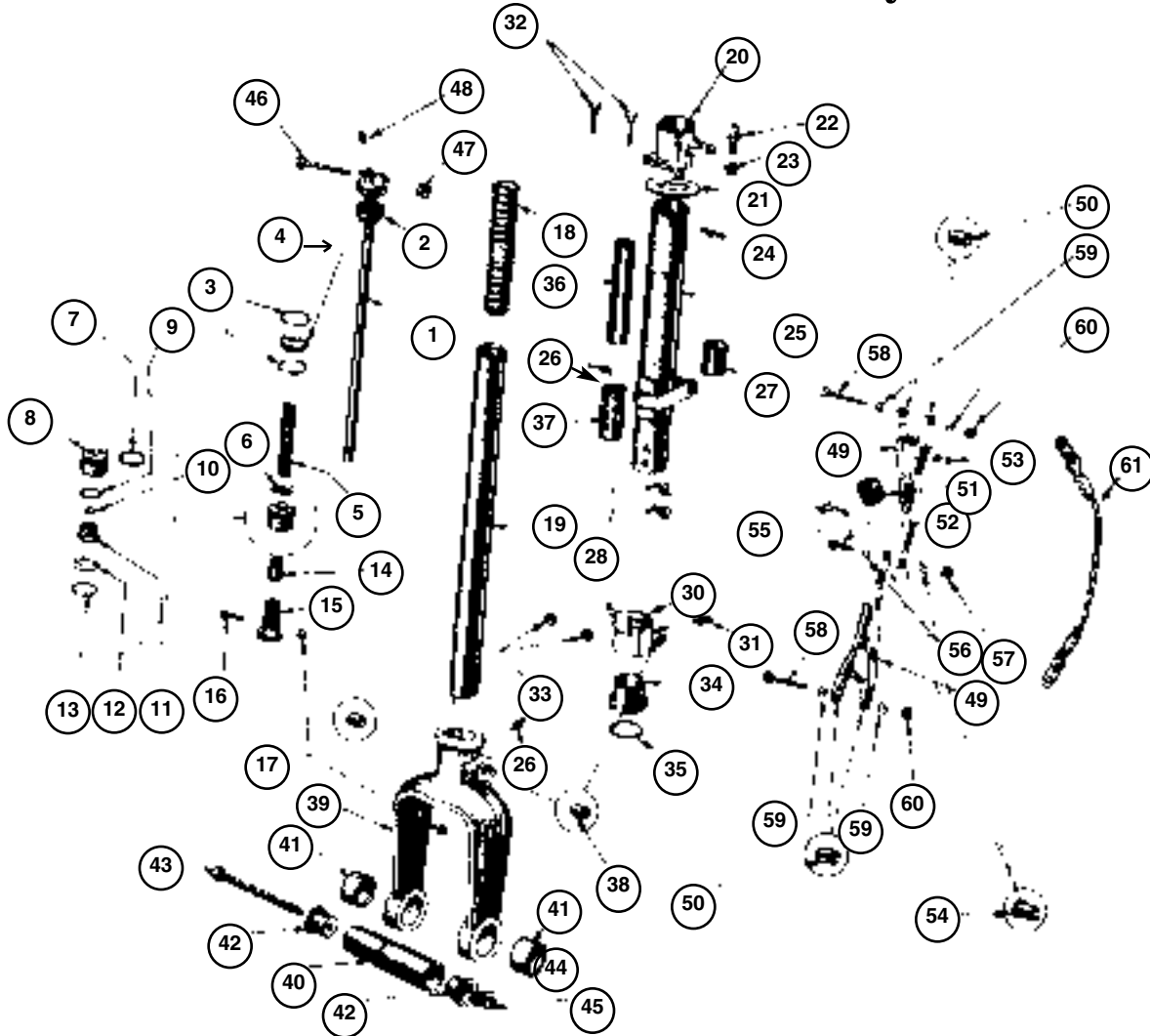

Fig#	Description	Part No.	No. Req'd.	Fig#	Description	Part No.	No. Req'd.	Fig#	Description	Part No.	No. Req'd.
1	Shaft Assy. with Head	F34420	1	23	Nut	AN364-624	1	42	Socket Bushings	F34372	2
2	Shock Absorber	F34325	1	24	Screw	AN510-10R4	2	43	Bolt	AN4-55A	1
3	Snap Ring	PC 595 NAS50-165	2	25	Outer Cylinder	F34410	1	44	Washer	AN960-416	1
4	Shaft Guide	F34343	1	26	Lube Fitting	PC 150 .1637-B	1	45	Nut	AN365-428	1
5	Spring	F34342	1	27	Upper Inner Bushing	F34412	1	46	Bolt	AN5-26	2
6	Washer	AN960D1016	1	28	Screw Lock	F34214	4	47	Nut	AN310-5	1
7	"O" Ring	PC 590 MS28775-215	1	30	Steering Sleeve	F34431	1	48	Plug	PC 590 MS20913-1S	1
8	Inner Plug	F34316	1	31	Lube Fitting	PC 599 1641B	1	49	Scissors Link	F34318	2
9	"O" Ring	PC 590 MS28775-220	1	32	Bolt	AN4-14A	2	50	Bushing	PC 595 NAS75-5-008	4
10	"O" Ring	PC 590 MS28775-114	1	33	Nut	AN365-428	2	51	Rubber Bumper	F34309	1
11	Collar Plug	F34332	1	34	Lower Outer Bushing	F34411	1	52	Screw	AN515-6-20	2
12	Washer	F34345	1	35	"O" Ring	PC 590 MS28775-225	1	53	Nut	AN365-632	2
13	Snap Ring (34351-1)	PC 590 MS16625-2143	1	36	Upper Spacer Tube	F34417	1	54	Bushing	F34339	2
14	Stop	F34344	1	37	Lower Spacer Tube	F34416	1	55	Bolt	AN5-11	1
15	Orifice Fitting	F34317	1	38	Bushing	415-34311	4	56	Washer	AN960-516	2
16	Bolt	AN4-11A	1	*	Wheel 5.00 x 5	PC 660 040-08700	1	57	Nut	AN310-5	1
17	Nut	AN364-428	1	*	Tire 5.00 x 5	PC 665 .500X5T4AT	1	58	Bolt	AN5-26	2
18	Spring	F34041	1	*	Tube 5.00 x 5	PC 665 .500X5U	1	59	Washer	AN960-516	4
19	Inner Cylinder Assy	F34305	1	39	Nose Fork (electrol)	F34371-1	1	60	Nut	AN310-5	2
20	Steering Collar	F34029	1		Nose Fork (steel)	F34371-2	1	61	Snub Cable	PC 125 .530062-000	1
21	Washer	F34051	1	40	Axle Shaft	F34373	1				
22	Socket Ball	415-34074-2	1	41	Spacer	F34374	2				

All AN Part Numbers are PC 580

All items on this page are Price Code 120 unless otherwise noted

Price and availability subject to change without notice. Univair's Toll Free Sales: 1-888-433-5433

Ercoupe-Forney-Alon-Mooney

Ercoupe Spinner Components

Any of the following combinations may be used on Ercoupe, Forney, Alon or Mooney.
However, you must select the proper assembly for your particular propeller and crankshaft combination.

Configuration	Part No.	Dome			Front Bulkhead		Rear Bulkhead		
		F40594	F40593	680030-001 PC 125	A40665-8	680029-004 PC 125	F40663-00	F40663-01	415-40592-1S
Metal Propeller — Flanged Crankshaft	X			X		X			
Metal Propeller — Tapered Crankshaft	X			X			X		
Wood Propeller — Flanged Crankshaft		X							X
Wood Propeller — Tapered Crankshaft		X					X		
Mooney/Alon Flanged Crankshaft			X		X	X			
Mooney/Alon Tapered Crankshaft			X		X		X		

Ercoupe Propeller Bolts

	McCauley Metal	Flottorp Wood
Flanged Crankshaft	PC 580 AN6H31A	PC 580 AN6H42A
Tapered Crankshaft	PC 580 AN6-34A	PC 580 AN6-42

Left to right:
Ercoupe/Forney
Wood Propeller
Assembly;
Ercoupe/Forney
Metal Propeller
Assembly;
Alon/Mooney New
Style Metal
Propeller Assembly



Engine and Cowling

Description	Part No.
Side Cowl Stiffener	415-40036-L/R
Engine Cowl Support Upper Longitudinal	415-40038-L/R
Bottom Cowl Assembly, less cover plate	415-40040
Bottom Longitudinal Assembly, DZUS type	415-40047-L/R
Cabin Heater Box Assembly	F40074
Upper Cowl Bracket Longitudinal Assembly	415-40080-L/R
Lower Cowl Bracket Longitudinal Assembly	415-40081-L/R
Side Cowl Assembly, DZUS type	415-40090-L/R
Spinner Bracket	415-40150
Muffler Attachment Clamp	415-40167
Bottom Exit Cooling Baffle Assembly	415-40169
Front Baffle Strap Tube	415-40196
Baffle Strap Barrel Tube	415-40197
Head Baffle Strap Rear Tube	415-40198
Nose Cowl Mounting Ring, DZUS	415-40244D
Nose Cowl Mounting Ring, CAMLOC	415-40244C
Side Cowl Gusset	415-40245
Bottom Cowl Cover Plate	415-40252
Left Hand Exhaust Stack Assembly	415-40401-S
Right Hand Exhaust Stack Assembly	415-40402-S
Right Side Baffle	415-40404

Engine and Cowling (continued)

Description	Part No.
Left Side Baffle	F40405
Rear Head Strap	415-40406
Front Head Strap	415-40407
Head Filler Baffle	415-40411
Front Barrel Strap	415-40412
Rear Barrel Strap	415-40413
Top Cowl Assembly, SN 113-2622	415-40422
Exit Attaching Barrel Clip	415-40424
Spark Plug Fairings	415-40428
Top Cowl Grommet	F40430
Carburetor Heater Opening Spring	415-40435
Nose Cowl Assembly without cold air intake opening	415-40451
Baffle Attaching Spring	415-40453
Exit Attaching Head Clip	415-40455
Barrel Baffle Support Center Strap Assembly	415-40457
Center Head Baffle Support Strap Assembly	415-40459
Nose Cowl Assembly with cold air coupling	415-40460
Right Rear Baffle Assembly	F40461
Left Rear Baffle Assembly (use with Oil Cooler Kit)	415-40473
Right Side Scoop	415-40486
Rear Baffle Attachment Clip	415-40490-L/R

Engine and Cowling (continued)

Description	Part No.
Oil Sump Cooling Scoop Assembly	415-40480
Left Side Scoop	F40485
Front Head Baffle Attachment Clip	415-40491-L/R
Top Left Baffle	F40496
Top Right Baffle	F40497
Oil Sump Baffle Strap	415-40502
Mixture Control Attachment Bracket	415-40503
Left Rear Baffle without Oil Radiator	F40504
Throttle Attachment Bracket	415-40506
Muffler Assembly	415-40511-1
Cabin Heater Shroud Assembly	415-40515
Flex Tube to Shroud Attachment Fitting	415-40519
Carburetor Heat Shroud Assembly	415-40520
Left Front Inner Baffle	415-40525
Left Front Baffle	415-40526
Heater Box Air Control Guide	415-40528
Top Cowl Assembly, SN 2623 and up	F40532
Winter Front Cover Plate	415-40554
Longitudinal Assembly, CAMLOC	F40558-L/R
Side Cowl Assembly, CAMLOC	F40559-L/R
Right Front Baffle	F40569
Air Filter Element	PC 275 40585-1
Starter Cable Support Bracket, SN 4424 and up	415-40591

Ercoupe-Forney-Alon-Mooney

Engine and Cowling (continued)

<i>Description</i>	<i>Part No.</i>
Metal Propeller-Spinner Dome	F40594
Rubber Baffle, 85 hp.....	415-40597
Rubber Baffle, 85 hp.....	415-40598
Oil Sump Baffle Assembly	415-40599

Nose Cowl Assembly



With no cold air intake hole	415-40451
With cold air intake hole	415-40460

Side Cowl Assembly



DZUS Fasteners	415-40090-L/R
CAMLOC Fasteners.....	415-40559-L/R

While they last! Cowling Emblems



Left Side.....	415-00012
Right Side.....	415-00011

Many parts can be correctly identified by the nomenclature listed in this section. However, on all aircraft for which UNIVAIR supplies parts, we suggest that you also have the correct parts manual for positive identification.

Engine and Cowling (continued)

Top Cowl

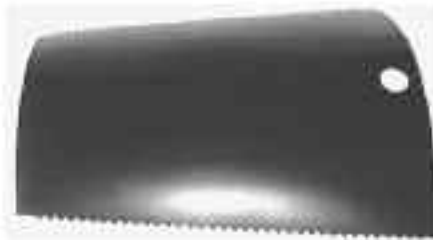

Top Cowl, SN 1-2622	415-40422
Top Cowl, SN 2623 and up	F40532

Carburetor Heat Shroud for all Ercoupe models



Part Number	415-40520
-------------------	-----------

Bottom Cowl



Part Number	415-40040
-------------------	-----------

Carburetor Induction Manifolds



For A-65, C-75, C-85, C-90	U35145
For O-200	U35145-A1

Price Code 201

Engine and Cowling (continued)

Air Filter Screen

415 Series (Paper Type)	40585-1
415 Series (Foam Type)	BA-8805



PC 275

Cabin Heat Shroud Assembly For all Ercoupe models after 1945



Part Number	415-40515
-------------------	-----------

Fuselage Tank Filler Neck Grommet



Part Number	F40430
-------------------	--------

Spark Plug Fairings

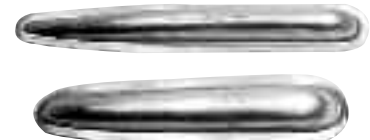

Mooney Fairing (top in photo, approx. 17 inches long)	F40253
Ercoupe Fairing (bottom in photo, approx. 14 ³ / ₄ inches long)	415-40428

Exhaust System for Ercoupe 415 Series and early Forney



Stainless Steel, Left Hand Stack	U-415-40401-S
Stainless Steel, Right Hand Stack	U-415-40402-S
Muffler	415-40511-1
Carburetor Heat Shroud.....	415-40520
Cabin Heat Shroud.....	415-40515

All items on this page are Price Code 120 unless otherwise noted

Price and availability subject to change without notice. Univair's Toll Free Sales: 1-888-433-5433

Ercoupe-Forney-Alon-Mooney

Oil and Fuel System

<i>Description</i>	<i>Part No.</i>
Oil Gauge to Firewall Tube Assembly (flared ends short).....	415-47016
Oil Gauge to Firewall Tube Assembly (flared ends long).....	415-47116
Oil Gauge to Firewall Tube Assembly (hose fitting forward).....	F47117
Fuel Gauge Sight Tube	415-48011
Sight Tube Washer.....	415-48014
Sight Tube Gasket.....	415-48016
Steel Fuselage Tank (48025 N/A)	U-415-48145
Filler Cap Gasket	A48049-S
Left Hand Tank to Tee Tube Assembly — steel tanks (SN 113-3220)	415-48060
Shut-Off Valve to Firewall Tube Assembly Pump Suction	415-48061
Fuselage Tank to Right Hand Tank Overflow Tube Assembly (SN 113-2622).....	415-48062
Firewall to Fuselage Tank Valve Tube Assembly	415-48063
Fuselage Tank to Firewall Tube Assembly Pump Pressure (SN 113-2622)	415-48064
Tee to Primer Tube Assembly	F48067
Primer to Firewall Tube Assembly	F48068
Wing Tank Fuel Cap for 9-gallon tank with breather hole	415-48073
Firewall to Primer Jet Tube Assembly ..	F48075
Filter Bowl Support	415-48076
Fuel Shut-Off Shaft and Handle Assembly (SN 113-2622)	415-8078
Wing Gauge Vent Tube (Steel Tank).....	415-48089
Union to Firewall Tube Assembly Pump Suction (SN 2623-3467)	415-48090
Filter Bowl Forward Support.....	415-48096
Aluminum Wing Tank Strainer Assembly	F48108
Aluminum Wing Tank to Tee Tube Assembly	415-48109
Tee to Cut-Off Tube Assembly Pump Suction Aluminum Tank.....	415-48110
Aluminum Tank Ring Gauge.....	415-48113
Gauge Cover (Aluminum Tank)	415-48119
Tee to Left Hand Tank Overflow Tube Assembly (SN 3221 and up)	415-48130
Fuselage Tank to Left Hand Tank Overflow Tube Assembly (SN 3221-3467)....	415-48131

6-Gallon Fuselage Tanks



For Ercoupe, welded aluminum,
 SN 2623 and up.....U-415-48145
(No Ears)
 For Forney, Alon

A48301
 For M-10..... **PC 125** .. 610181-501

Oil and Fuel System (continued)



Gas Tank Gasket.....A48049-S

Description

Part No.

Firewall to Fuselage Tank Tube Assembly Pump Pressure (SN 3221 and up).....	415-48132
Fuselage Tank to Fitting Overflow Tube Assembly (SN 3468 and up)	415-48133
Fitting to Left Hand Tank Overflow Tube Assembly (SN 3468 and up)	415-48134
Aluminum Wing Tank Fuel Gauge Cover ..	F48138
Shut-Off to Tee Tube Assembly Pump Suction (SN 4424 and up)	F48149
Tee to Left Hand Tank Overflow Tube Assembly (SN 4424 and up)	F48152
Wing to Tee Tube Assembly (SN 4424 and up)	415-48155
Tee to Right Hand Tank Overflow Tube Assembly (SN 4424 and up)	F48156
Fuselage Tank to Tee Overflow Tube Assembly (SN 4424 and up)	F48157
Tee to Tee Interconnecting Tube Assembly (SN 2623-3220)	415-48159
Tee to Elbow Overflow Tube Assembly (SN 2623-3220)	415-48161
Tee to Elbow Overflow Tube Assembly (SN 2623-3220)	415-48162
Fuselage Shut-Off to Firewall Tube Assembly	415-48163
Firewall to Fuselage Tank Tube Assembly Pump Pressure	415-48164

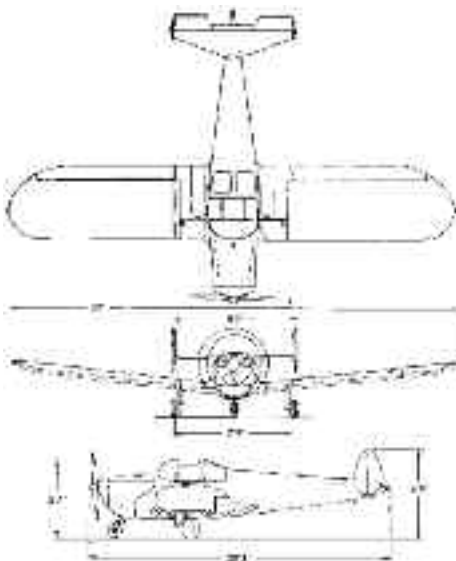

Oil and Fuel System (continued)

Description

Part No.

Union to Firewall Tube Assembly (SN 3468 and up)	415-48165
Fuselage Shut-Off to Firewall Tube Assembly	F48166
Firewall to Fuselage Tank Tube Assembly (SN 3468 and up)	F48167
Reducer to Elbow Service Line	415-48175
Reducer to Left Hand Wing Tank Service Line	415-48176
Forward Side of Frame "D" to Fuselage Tank Service Line	415-48177
9-gallon Wing Tank Unvented Fuel Cap (SN 4424 and up)	F48183
Fuel Tank Cap and Gasket Assembly (late Alon & M-10) thermos type	PC 125 .. 610014-001
Cut-Off to Union, Tube Assembly	415-48188
Oil Pressure Hose	F48201-1
Pump Hose	F48201-3
Carburetor Hose	F48201-4
Oil Breather Hose	F48201-5
Oil Breather Tube (48201-6)	SK-38

Welded 9-Gallon Wing Tank



For Forney, Alon and M-10 Models
 With gauge in left hand tank

Left Hand Tank (48147)	PC 125 .. 610182-501
Right Hand Tank.....	PC 125 .. 610182-503

Instruments

Description

Part No.

Pitot Tube Assembly	F51002
Non-Spin Characteristic Nameplate (SN 113-812)	415-51007
Fuel Shut-Off Dial Plate (SN 113-4423).....	415-51019
Glove Compartment Door Spring.....	415-51020
Glove Compartment Knob (51021)	415-52244
Glove Compartment	415-51028-L/R
Phenolic Guide (51041)	415-52150
Ignition Switch (51029-1) ..	PC 245 .. 10-357290-1
Instrument Panel Trim Strip (SN 113-4423)	415-51045

Ercoupe-Forney-Alon-Mooney

Instruments (continued)

<i>Description</i>	<i>Part No.</i>
Throttle Assembly (SN 113-4423) 51048 use PC 283 A800-10-0480	
Starter Control (SN 113-4423)	415-51052
Compass Card Cover (SN 113-4423)	415-51062
Elevator Trim Control Plate (SN 123-1622)	415-51064
Brake Control (SN 113-4423)	415-51065
Cabin Heat Control	415-51069
Mixture Control (SN 113-4423)	415-51070
Characteristic Name Plate (SN 3623-4424)	415-51078
Wheel Guide Control Packing	F51083-26
Panel Top Overlay (SN 4423 and up)	415-51084
Panel Bottom Overlay	415-51085
Trim Control Arm, without handle (SN 4423 and up)	415-51089
Throttle Control, female handle (SN 4424-4868)	415-51090-1
Throttle Control, male handle (SN 4424-4868)	415-51090-2
Trim Arm, without handle (SN 4424 and up)	F51091
Trim Control Collar (SN 4424 and up) ..	F51092
Trim Control Female Handle (SN 4424-4868)	415-51093-1
Trim Control Male Handle (SN 4424-4868)	415-51093-2
Throttle Catch Pawl (SN 4424 & up)	415-51094
Glove Compartment Door (SN 4424 and up)	415-51096
Throttle Catch Barrel (SN 4424 & up) ..	415-51098
Throttle Catch Disc (SN 4424 & up)	415-51099
Square Knob Control (415 C & D)	415-51104
Carburetor Heat Control	415-51105
Starter Control (SN 4424 and up)	F51106
Trim Cable Clamp (SN 4424 and up)	415-51108
Trim Torque Tube Support (SN 4424 and up)	415-51109
Bellcrank and Torque Tube (SN 4424 and up)	F51111
Throttle Quadrant Spring Retainer Screw (SN 4424 and up)	415-51112
Trim and Throttle Control Quadrant Bearing	F51114
Throttle Catch Spring (SN 4424 & up)	415-51116
Throttle Control Shaft (SN 4424 & up)	415-51117
Throttle Catch Ratchet Rack (SN 4424 and up)	415-51118
Throttle Catch Ratchet Washer (SN 4424 and up)	415-51119
Trim Nameplate (SN 4424 and up)	415-51121
Quadrant Housing (SN 4424 and up)	F51123
Throttle and Trim Control Quadrant Assembly (SN 4424 and up)	F51124

Instruments (continued)

<i>Description</i>	<i>Part No.</i>
Trim Panel (SN 4877 and up)	415-51125
Bottom Overlay (SN 4424-4868)	415-51133
Nav. light Plate	415-51135
Characteristic Nameplate, 415-D, -E	415-51136
Throttle Control Assembly (SN 4424 and up)	415-51138
Trim and Throttle Control Quadrant to Cable Rod (SN 4424 and up)	F51139
Ercoupe Compass Plate (SN 4424-4868) ..	415-51140
Ignition Switch Plate (SN 4424 and up) ..	415-51142
"No Smoking" Plate	415-51143
415-CD Plate (FAA letter required)	415-51149
415-E and 415-G Plate (FAA letter req'd) ..	415-51150
Cabin Air Control	415-51158
Front Antenna Bracket	415-51166
Fin Antenna Bracket	415-51167

Modernize Your Ercoupe Panel



Blank Instrument Panel

Part Number 415-51081-B

Lay out your own instrument and radio arrangement using the UNIVAIR Blank Ercoupe Panel which has locating holes only for the two control columns. FAA field approval required.

Control Surfaces

<i>Description</i>	<i>Part No.</i>
Rudder to Center Bellcrank Pushrod Assembly	415-52022
Bellcrank to Elevator Pushrod	415-52023
415-E and 415-G Bellcrank to Elevator Pushrod	415-52024
Stall Warning Spring	415-52026
Link	415-52027
Washer	415-52028
Center Section to Aileron Pushrod	F52034
Nose Gear Pushrod including Socket without Bearing	415-52035
Check Nut (52035-2) PC 580 ..	AN316-6
Column to Mast Pushrod	415-52036
Control Mast to Bellcrank Aileron Pushrod	415-52038
Control Column to Elevator Crank Pushrod	F52039
Control Mast Rudder Arm	F52040

Control Surfaces (continued)

<i>Description</i>	<i>Part No.</i>
Control Mast Support	F52047
Control Wheel Assembly (SN 1-4423)	415-52055-6
Nose Landing Gear Pushrod Control Guide	F52056
Control Mast Assembly	F52057
Control Mast Support Bearing (52057-2)	PC 580 AN201-K10A
Retainer Ring (52057-6)	PC 595 NAS50-137
Control Mast Shaft	415-52058
Control Mast Arm	415-52068
Trim Control Wire	F52070-33
Control Column Chain Assembly	415-52107
Control Shaft and Column Universal Joint	415-52113
Elevator Control Stop	415-52115
Taper Pin (52117-16)	PC 580 AN386-1-6
Control Column Assembly	F52118
Control Column Base Bearing (52118-3)	PC 580 AN200-K4
Control Column Sprocket Bushing (Oilite A626-3)	F52118-6
Upper and Lower Control Column Bushing	415-52119
Control Column Inner Shaft Assembly	F52129
Control Column Base Assembly	F52135
Control Column Quadrant	415-52137
Control Column Sprocket Assembly	415-52140
Control Column Shim	415-52149
Control Wheel Guide	415-52150
Lubricating Control Wheel Shaft Washer ..	415-52152
Quadrant Stop Bolt	F52169-2
Quadrant to Chain Cable Assembly	F52172-S
Bellcrank Elevator Arm (SN 113-4868)	415-52204
Elevator Arm (SN 4877 and up)	415-52204-E
Elevator Arm Large Bushing (Oilite A710-3)	415-52204-1
Elevator Arm Small Bushing (Oilite S301-A)	415-52204-2

Ercoupe Control Wheel Original Control Wheel for Ercoupe



SN 1-4423 415-52055-6

Ercoupe-Forney-Alon-Mooney

Control Surfaces (continued)

<i>Description</i>	<i>Part No.</i>
Elevator Control Rear Bracket	415-52207-1
Elevator Horn and Bracket Assembly, less cable	415-52208
Elevator Arm Shaft	415-52208-1
Elevator Control Cable	415-52225
Center Section Elevator Cable Fairlead	415-52226
Center Section Rudder Cable Fairlead	415-52227
Elevator Control Center Section Arm Assembly	415-52228
Front Beam Trim Cable Fairlead	415-52237
Elevator Trim Control Spring	415-52242
Center Section Front Beam Elevator Control Assembly	F52245
Fork (52245-5)	PC 580 AN161-32RS
Elevator Control Arm Bushing	415-52246
Front Beam and Diagonal Rib Fairlead (SN 123-1623)	415-52247
Instrument Panel Trim Unit Assembly (SN 123-1623)	415-52255
Worm Gear Assembly	415-52263
Elevator Trim Cable (SN 123-1623)	415-52268
Trim Crank Handle (SN 123-1623)	415-52269
Trim Unit Drum Guard	415-52271
Stabilizer Trim Wire Flexible Conduit	F52274
Trim Wire Conduit	415-52275
Trim Flexible Conduit (SN 1623-4423)	415-52277
Trim Flexible Conduit (SN 4424 and up)	F52281
Aileron Bellcrank Assembly	F52305
Aileron Bracket Assembly	F52306-L/R
Aileron Bracket and Bellcrank Assembly	F52307-L/R
Center Section Aileron Bellcrank Bearing (52307-1)	PC 570 AN201-KP4A
Elevator Control Bellcrank Bushing	415-52404
Crank	415-52420
Rudder Cable Assembly	415-52423
Stabilizer Bellcrank and Bracket Assembly (52424)	415-52404, F52425, 415-52427
Stabilizer (Rudder Bellcrank) Bracket	F52425
Rudder Bellcrank Spacer	415-52426
Rudder Bellcrank Assembly	415-52427

Furnishings

<i>Description</i>	<i>Part No.</i>
Seat Bottom Assembly	415-53004
Seat Back Side Member	415-53007-L/R
Seat Back Top Rail	415-53008
Seat Back Bottom Rail	415-53009
Seat Back Center Member	415-53010
Gusset	415-53013
Seat Back Frame (53016-A)	415-53016-B
Lower End Stiffener	F53022-2
Sliding Window Stiffener Assembly	F53022-3
Right Hand Window Assembly, Clear	415-53023
Right Hand Window Assembly, Tinted	415-53023G

Furnishings (continued)

<i>Description</i>	<i>Part No.</i>
Male Upper End Assembly (53024A)	415-53052-3
Left Hand Window Assembly, Clear	F53024
Left Hand Window Assembly, Tinted	F53024G
Safety Belt Fastener Shackles	415-53037
Clear Sliding Window, plexiglass only	F53041
Tinted Sliding Window, plexiglass only	F53041G
Seat Back Lower Gusset	415-53046
Seat Back Center Member to Top Clip Bracket	415-53047
Outside Handle	F53048
Female Upper End Frame	415-53051
Lower End Frame	415-53052-2
Green Tint Sunshade, glass only	415-53057G
Smoke Tint Sunshade, glass only	415-53057S
Green Tint Sunshade Assembly	415-53058G
Slanting Floorboard Assembly	F53059-1
Lower Floorboard Assembly	F53069
Floorboard Cover Plate	415-53070
Rear Deck	415-53071-1
Inside Handle	415-53075-1
Outside Handle	415-53075-2
Window Bolt	415-53076
Floorboard Support	F53080
Map Compartment	415-53108-L/R
Fastener	415-53121-6
Side Cabin Soundproofing	415-53137-L/R
Lower Firewall Soundproofing	415-53138
Upper Firewall Soundproofing	415-53139
Window Channel Welts (priced each)	415-53169
Rug Assembly	F53174
415-G Rug Assembly	F53174-G
Baggage Compartment	API-53175
Map Compartment Mounting Clip	415-53209
Draft Seal	F53212-L/R

Ercoupe Window Welts



2 required per plane (priced each).....415-53169

If you don't find the part you need
be sure to give us a call.
We are here to help you with all of
your classic aircraft needs!

Electrical

<i>Description</i>	<i>Part No.</i>
Junction Box (31160-17)	PC 625 40099
Battery Box, with extended sides (excludes lid)	415-54035
Battery Box Wing Bolt Assembly	415-54037
Battery Box Cover, with rubber seal	415-54040
Master Switch Nameplate	415-54045
Starter Cable to Starter Arm Rod End	415-54046
Master Switch Guard	415-54047
Battery Box Decal	415-54062
Master Switch (53071-4)	PC 150 487-793

Batteries

See Lighting and Electrical Supplies section in this catalog.

Bushings and Bearings

<i>Description</i>	<i>Part No.</i>
Control Mast Support Bearing	PC 580 AN201-K10A
Control Column Base Bearing	PC 580 AN200-K4
Control Column Pushrod Bearing (MD36-14M)	PC 570 GMM-3M-670
Cone Bearing, Goodrich 7.00x4 Wheel	08125
Bearing Race, Goodrich 7.00x4 Wheel	08231
Center Section Aileron Bellcrank Bearing	PC 580 AN201-KP4A

Bushings and Bearings are PC 570

M-10 Cadet

<i>Description</i>	<i>Part No.</i>
Air Filter (40599)	PC 275 600314
Left Hand Aileron	230025-001
Right Hand Aileron	230025-002
Canopy Glass (340237-006)	PC 120 13270-6
Dorsal Fin	350178-000
Horizontal Stabilizer	420002-001
Rudder	460044-001
Tail Cone Lens	470011-013
Fuselage Fuel Tank	610181-501
Left Hand Fuel Tank	610182-501
Right Hand Fuel Tank	610182-503
Spinner Rear Plate (680028-000)	PC 120 40663-00
Spinner Front Plate	680029-004

M-10 Cadet items are PC 125

Ercoupe-Forney-Alon-Mooney

Service Kits

<i>Kit Part Number</i>	<i>Description</i>	<i>Early Kit Number</i>
SK-1	Rudder Bellcrank Modification Kit (complies with AD 67-06-03)	FMK-26
SK-2	CAMLOC Fastener Repair Kit (fasteners only)	
SK-2A	DZUS Fastener Repair Kit (fasteners only)	
SK-3	Cowl Fairing; streamlined fairing, for shielded ignition	FMK-4
SK-3A	Cowl Fairing; streamlined fairing, for shielded ignition on M-10 Cadet	
SK-4	Trim Tab Control Conversion Kit (less tab) for 415 series; for C-75 to C-85 conversion	
22031 (SK-4A)	Trim Tab (tab used when SK-4 is installed)	
SK-5	Installation Kit for Gas Tanks part number 48197-L/R (less tanks)	
SK-6	Large Full View Window Kit (Forney hat and map shelf required)	FMK-6
SK-7	Fuel Pump Modification Kit (complies with AD 47-20-03)	
SK-8	Battery Box Modification Kit as per Ercoupe Bulletin #22	
SK-9	Rear Spar Reinforcement Kit (complies with AD 59-05-04)	FMK-19
SK-10	Cabin Fresh Air Intake Kit	FMK-30
SK-12	Battery Box Conversion Kit (large to small battery)	
SK-14	Trim Tab Stop Kit (complies with AD 50-07-01)	
SK-15	Bubble Windshield Conversion Kit, complete, clear	FMK-11
SK-15A	Bubble Windshield Conversion Kit, complete, tinted	FMK-11A
SK-16	Wing Landing Light Kit (used with metal wings)	FMK-16
SK-17	Nose Gear Assembly, latest design for all models (see illustration on page 3-6)	
SK-17A*	Nose Gear Double Arm Fork Conversion (see illustration on page 3-6)	FMK-18
SK-17B*	Nose Gear Double Arm Fork Conversion (see illustration on page 3-6)	FMK-17
SK-17C*	Nose Gear Double Arm Fork Conversion (see illustration on page 3-6)	FMK-17
SK-17D*	Nose Gear Conversion Kit (for Steel Gear); same as Kit SK-17A and SK-17B except for hard chrome inner cylinder installed	
SK-17E*	Nose Gear Conversion Kit; same as SK-17D except machined for Electrol Gear	
SK-17F*	Scissors Modification Kit; replaces welded steel scissors with forged aluminum scissors	
SK-17G*	Upper Nose Gear Cylinder Assembly; replaces upper part of nose gear (description on page 3-6)	
SK-18	Forney Hat Shelf Kit	
SK-20*	Anti-Collision Strobe Light Kit (replaces Beacon with Strobe)	
SK-20A*	Anti-Collision Strobe (bottom) for original installation	
SK-20B*	Anti-Collision Strobe (top and bottom) for original installation	
SK-20C*	Anti-Collision Strobe Kit (to replace Model E Lights with Strobes)	
SK-20D*	Anti-Collision Strobe Kit; 3-strobe system (see illustration on page 3-16)	
SK-21	Rudder Pedal Kit (see illustration on page 3-16)	
SK-22	Control Wheel Shaft Bushing Kit	FMK-21
SK-23	Cowl Support Kit; "Scalp-Saver Kit"	
SK-24	Oil Tank Baffle Cooling Kit for C-75 to C-85 conversion	
SK-27	Cabin Heat Box Modification Kit	FMK-25
SK-28	Landing Light Installation Kit (see illustration on page 3-17)	
SK-29	Canopy Cover Kit	
SK-31-LB	Nose Gear Service Kit for Steel Gear, less bronze bushing	
SK-31-WB	Nose Gear Service Kit for Steel Gear, with bronze bushing	
SK-31A-LB	Nose Gear Service Kit for Electrol Gear, less bronze bushing	
SK-31A-WB	Nose Gear Service Kit for Electrol Gear, with bronze bushing	
SK-31B-LB	Nose Gear Service Kit for late Forney and Alon, less bronze bushing	
SK-31B-WB	Nose Gear Service Kit for late Forney and Alon, with bronze bushing	
SK-31C-LB	Nose Gear Service Kit for Mooney M-10, less bronze bushing	
SK-31C-WB	Nose Gear Service Kit for Mooney M-10, with bronze bushing	
SK-32A	Main Gear Oleo Service Kit (Piston and O-Rings) for SN 813 and up; 2 required	
SK-33	Oil Access Door Kit	FMK-1
SK-33A	Large Oil Access Door Kit	
SK-35	Belleville Spring Kit (see illustration on page 3-17)	FMK-9
SK-36	Rudder Rib Kit (complies with AD 59-25-05) (Provides parts for both sides)	FMK-22
SK-37	Fuselage Drain Installation Kit as per Service Bulletin #109	FMK-27
SK-38	Oil Breather Tube Re-routing Kit as per Service Bulletin #108	FMK-28
SK-39	Fuel System Drain Modification—Quick Exterior Drain as per Service Bulletin #111	FMK-29
SK-42	Installation of Improved Rudder Pedal Centering Spring	MK-2

*** FAA Field Approval Required.**

All items on this page are Price Code 120 unless otherwise noted

Price and availability subject to change without notice. Univair's Toll Free Sales: 1-888-433-5433

Ercoupe-Forney-Alon-Mooney

Service Kits (continued)

<i>Kit Part Number</i>	<i>Description</i>	<i>Early Kit Number</i>
SK-45	Fresh Air Conversion Kit for Alon and Mooney	MK-6
SK-46	Anti-Ice Deflectors; eliminate icing between aileron and wing center section; for all models 415 through Mooney Cadets	MK-7
SK-48-L	Center Section Butt Rib Repair Kit, Left Hand	
SK-48-R	Center Section Butt Rib Repair Kit, Right Hand	
SK-49	Fuel Filler Neck Modification per Alon Bulletin #16, section I, step 4	
SK-50	Fuel Filler Cap Fuselage Tank Modification as per Alon Bulletin #16, section II, step 1	
SK-51	Wing Tank Fuel Caps Modification per Alon Bulletin #16, section II, step 2	
SK-52	Wing Tank Fuel Caps Modification per Alon Bulletin #16, section I, II and III	
SK-53A	Canopy Latch Kit, Nelson type	
SK-54*	Model E Grimes Light Adapters for installing wing tip strobes	
SK-55*	Model E Grimes Light Adapters and two model E light assemblies—one red, one green; can be used with Whelen A650 Strobe Light	
SK-56*	Tail Cone Assembly; used when Whelen A555 or A550 light is used	
SK-57	Nose Gear Steering Rod End Connection Kit (see page 19 for details)	
SK-58	Main Gear Brake Hose Kit (One kit services one landing gear strut.)	
SK-64	Alon Exhaust Stack Flexible Support	
SK-75	Handbrake Installation Kit	
SK-76	Service Kit, Complies with Service Bulletin 24B, For Ercoupe 415-C, 415CD, 415D, 415E, & 415G	
SK-76F	Service Kit, Complies with Service Bulletin 24B, For Forney F-1 and F-1A	
SK-76G	Service Kit, Complies with service Bulletin 24B, Same as SK-76, (except kit includes a new aluminum gascolator)	
SK-76FG	Service Kit, Complies with service Bulletin 24B, Same as SK-76, (except kit includes a new aluminum gascolator)	
SK-78	Alon LH Seat Rail Kit	
SK-78A	Alon RH Seat Rail Kit	
SK-80-1	Service Bulletin 31-Method 1 Service Kit (For Aircraft with smooth center section bottom skins)	
SK-80-2	Service Bulletin 31-Method 1 Service Kit (For Aircraft with beaded center section bottom skins)	

* FAA field approval required

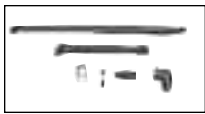

SK-76 KIT

SK-76.....Service Kit for Ercoupe 415C,415CD,415D,415E,415G-- Includes brass nipple and elbow, braces & nec. hardware.
SK-76F.....Service Kit for Forney F-1 & F-1A--Includes brass nipple and elbow, braces and necessary hardware. This kit is also applicable on 415 series Ercoupes with Marvel-Shebler (Precision) carburetors.

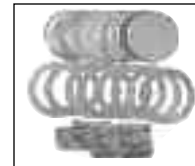

Service Bulletin 31-Method 1 Service Kit for aircraft with smooth center section bottom skins.....**SK-80-1**



SK-76G KIT

SK-76G.....Service Kit--Same as the SK-76 Kit, but includes a new aluminum gascolator with quick drain for aircraft requiring gascolator replacement.
SK-76FG...Service Kit--Same as the SK-76F Kit, but includes a new aluminum gascolator with quick drain for aircraft requiring gascolator replacement.

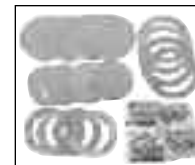

Service Bulletin 31-Method 1 Service Kit for aircraft with beaded center section bottom skins.....**SK-80-2**

Rudder Pedal Control Kit

The rudders are completely disengaged from the aileron system and therefore independent of the lateral controls, allowing the airplane to be flown in slips, and misuse of the rudder pedals can be demonstrated in flight. It is not necessary to use the rudder pedals in excess of 70 miles per hour, due to the efficiency of the aileron system.



The Rudder Pedal Kit consists of foot rest with rudder pedals mounted, cables to connect the rudder pedals to the rudder system with installation parts, hardware and drawings.....**SK-21**

Note: This kit will require the hand brake installation kit (SK-75). This kit is sold separately.



Strobe Light Kits (FAA field approval required)

Single Strobe Beacon. A direct replacement for bottom fuselage Whelen HR-CF (Comet Flash) Strobe**SK-20**

Single Strobe Beacon. Provides for the installation of a Whelen HR-CF Strobe Unit in the bottom of the fuselage for aircraft that currently has no strobe or beacon unit. **SK-20A**

Two-Strobe Fuselage Mounted System. Kit includes a power supply and two Whelen A470A Strobe Lights (one red, one clear)**SK-20B**

Wing Tip Mounted Two-Strobe System. Whelen A413 Power Supply and two A650-PG and -PR Strobe Lights (This kit must be used in conjunction with the SK-54 kit, which must be purchased separately.)**SK-20C**

Three-Strobe Wing and Tail Mounted System. Kit includes Power Supply, two wing tip strobes and one tail strobe (This kit must be used with the SK-54 and SK-56 kits, which must be purchased separately.)**SK-20D**

Ercoupe-Forney-Alon-Mooney

Service Kits (continued)

New Style Tail



Streamline your Ercoupe with the Alon Tail Cone. Facilitates installation of Tail Mounted Strobe. Gives your Ercoupe that New Look.

Part NumberSK-56

Clear Lens for New Style Tail Cone



Part Number **PC 125**470011-013

Landing Lights



The Ercoupe Landing Light System is supplied complete with two lights, one for each main landing gear fairing, and wiring with terminals installed for connecting these lights to switches which are provided. Instructions for installation and a wiring diagram are also included.

Part NumberSK-28

Wing Landing Light Lens



Part NumberF14099

Service Kits (continued)

Belleville Springs for Ercoupe Main Landing Gear (Replaces 33115 Rubber Shock Pads)



14 required for aircraftA33251
(priced each)

Belleville Spring Kit

Smoother ride on rough fields, better taxiing control, reduces "pitch" (less wear to nose gear parts), reduces wing "oil canning" on ground. Reduces landing shock, affords added protection to rear spar, raises tail to proper level.

Kit consists of 14 Bellevilles (complete for both gears), new O-Rings, 6 spacers, 2 flanges and installation instructions.

Belleville Spring Kit
(shown installed)
.....SK-35



Nose Gear Steering Ball

This is the original type steering ball as used on Ercoupe, Forney and Alon.



Part Number415-34074-2

Oil Access Door Kit



This kit comes complete with instructions and hardware. Provides access to oil filler without the necessity of opening the cowl on pre-flight checks. (Size 4¹⁵/₁₆ in. X 6¹/₄ in.)

Part NumberSK-33

Service Kits (continued)

Large Oil Access Door Kit



Same as the SK-33 Oil Door Kit, but provides for a larger door (9-5/8 X 12 inches). Door fastens with two easy-to-use, wing-type fasteners.

Part NumberSK-33A

Windows and Windshields Ercoupe 415 and Forney



Flat Windshield (.080)415-31042
Bubble Windshield (.125)F31232
Sliding Window, Glass Only
(.060)F53041
Sliding Window, Assembly
Left Hand (.060)F53024
Sliding Window, Assembly
Right Hand (.060)415-53023
Ercoupe Rear Glass Only (.060)415-31037

Alon A2, A2A
Left Hand Rear Window (.080)A13250-53
Right Hand Rear Window (.080)A13250-54

Alon A2, A2A and Mooney M-10
Left Half Windshield (.125)A13260-7
Right Half Windshield (.125)A13260-8
Canopy Window, Clear (.125)A13270-6
Canopy Window, Green (.125)A13270-7

Mooney M-10 Cadet
Left Hand Rear Window (.080)
..... **PC 125** 310265-019
Right Hand Rear Window (.080)
..... **PC 125** 310265-020

Note: For green tint, please add "G" to the part number.
For more Ercoupe windows and windshields, see the Windows and Windshields section of this catalog.

Ercoupe-Forney-Alon-Mooney

Service Assemblies

Service Assembly Number 1

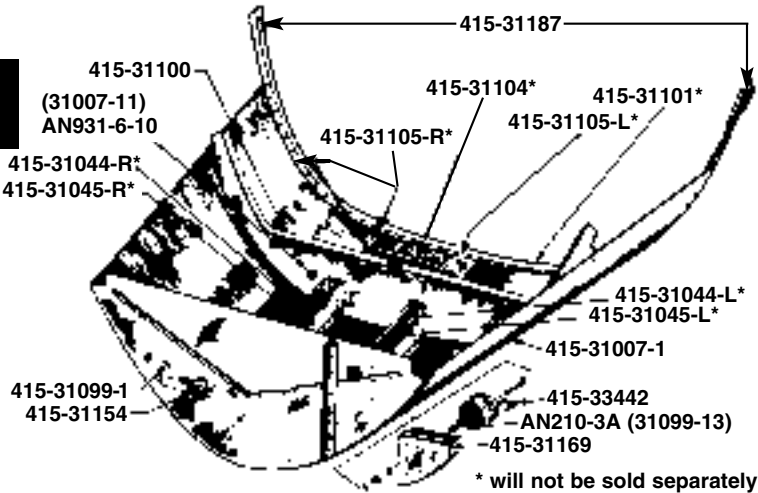

Lower Forward Fuselage Assembly SA-1

FRAME "C" COMPONENTS

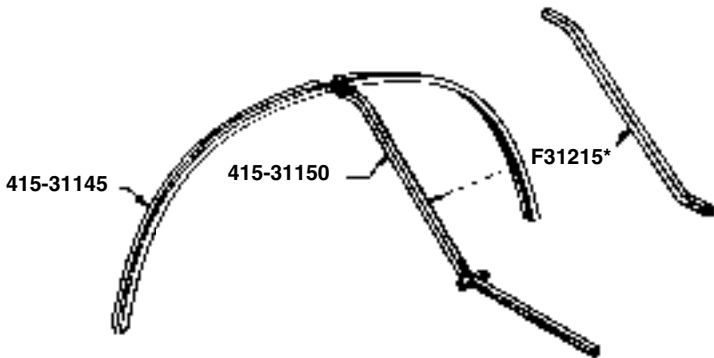

Frame Assembly "C" new type (SN 1-2622)**
 Frame Assembly "C" new type (SN 2623 and up)**

** Order components- not sold as an assembly.

Service Assemblies

- Left or Right Replacement Edge Assembly Side Cowling with CAMLOC Fasteners (FAA field approval required).....SA-22-L/R
- Left or Right Replacement Edge Assembly Side Cowling with DZUS Fasteners (FAA field approval required).....SA-23-L/R
- Left or Right Outer Panel Rear Spar Repair SectionSA-24-L/R

Service Assemblies (continued)

Service Assembly Number 3

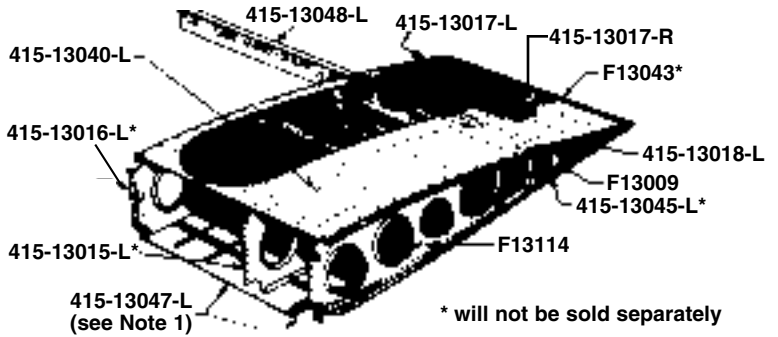

- Left Hand Walkway Box Service Assembly (illustrated), effective on Ercoupes with SN prior to 813SA-3
- Right Hand Walkway Box Service Assembly effective on Ercoupes with SN prior to 813SA-4

- Left Hand Walkway Box Service Assembly effective on Ercoupes with SN 813 and upSA-3A
- Right Hand Walkway Box Service Assembly, effective on Ercoupes with SN 813 and upSA-4A

In all cases where a letter appears after a part number, transpose R for L, or vice-versa, when ordering parts for right hand walkway boxes.

Note 1: 13047 used with Service Assemblies 3 and 4 may be identified by depth of cut, indicated by the broken line arrow 3-7/8 inches. Use 13147 with Service Assembly 3A/4A. Depth of cut in this assembly is 5-1/16 inches.

Fuselage Rear Top Skin

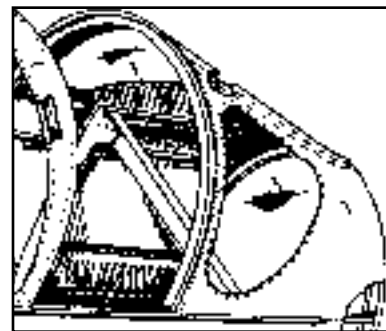

Part NumberF31160-3

UNIVAIR is THE Ercoupe Factory!
 As the Type Certificate holder for Ercoupe, Forney, Alon and Mooney M-10, we have an inventory of thousands of different Ercoupe parts available.
 If you do not see something you need, call, write, e-mail, or fax UNIVAIR today!